

# STR+ Steel Frame

## Contents

Application options	2
Basis of calculation	4
Data entry	5
Basic parameters	5
Structural system	7
Cross-sections	7
Border conditions	8
Column base	8
Loads	9
Design	10
Ultimate limit states	10
Serviceability limit states	10
Design of the connection details	11
Enhanced stability verifications – interface BTII+	11
Output	12

## Basic Documentation – Overview

In addition to the individual program manuals, you will find basic explanations on the operation of the programs on our homepage [www.frilo.com](http://www.frilo.com) in the Campus-download-section.

*Tip: Go back - e.g. after a link to another chapter / document - in the PDF with the key combination "ALT" + "left arrow key".*

## Application options

The STR+ program is suitable for the calculation of steel frames. Both two-hinged and restrained frames can be modelled. Cantilevers can be defined on both sides.

Bracing frames for example, as are common in building renovation, or common substructures can be calculated with just putting in a few data.

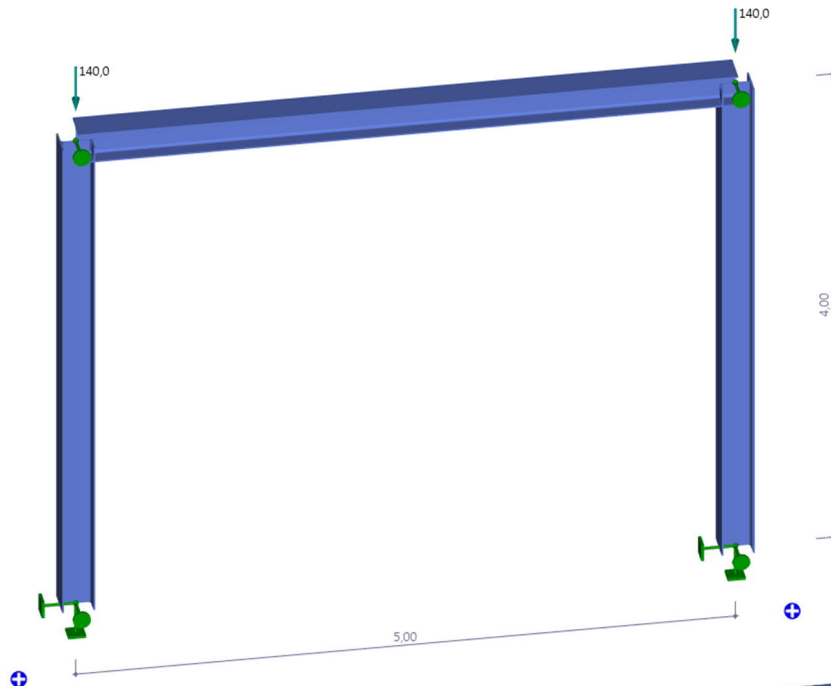

The column bases can be designed as hinged or restrained. Connections in the frame corners can be defined hinged, flexurally rigid or by specifying a torsion spring if the rotational stiffness in the respective connection is known.

In addition to simple systems, it is also possible to model one-bay frames with different column heights or half-frames. Moreover, spring values can be set in the base points for end restraint and horizontal displacement. If a frame corner is modelled as a rigid corner, the column can be connected to the crossbeam either with a hinged connection or with a spring value.

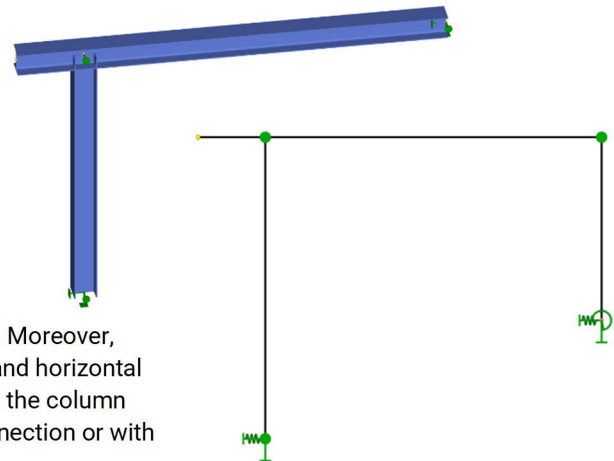

### Available standards

The STR+ program performs structural safety analyses in accordance with EN 1993-1-1 and takes the corresponding National Annexes into account:

- DIN EN 1993-1-1/NA
- ÖNORM B 1993-1-1

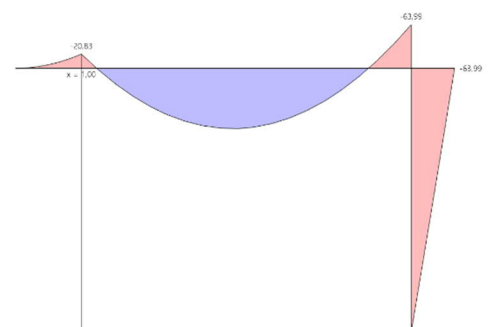

## Verifications

The internal forces are determined by means of the elastic frame method. The load combinations decisive for the design are calculated in a second-order analysis with consideration of the initial sway imperfection.

All necessary combinations of actions are automatically considered in accordance with the safety concept set forth in EN 1990.

The verification of the cross-sectional resistance is based on the limit plastic internal forces. You can optionally select the theory of elasticity as a verification method.

In the examination of components perpendicular to the frame plane, lateral supports, torsional and translational restraints can be taken into account.

The software calculates the deformations of the structural system as well as the relative deformations of the individual components in the serviceability limit state in accordance with the selected design situation.

The support reactions are put out separately for each load case including the characteristic loads and/or the design loads resulting from the second-order analysis.

## Load transfer and interfaces

Interfaces to the programs

- SRE+ Frame Corner Steel
- ST10 Screwed Frame Corner and
- ST14 Welded Frame Corner

are available for the design of the frame corners.

You can transfer loads to the programs

- ST3 - Base Plate Steel Column or
- ST6 - Restrained Base of Steel Column as well as to
- FD+ / FDB+ Foundation and Block Foundation.

If you have a valid licence for the BTII+ program (Lateral Torsional Buckling Analysis) you can transfer the structural system to BTII+. The program BTII+ allows the calculation of more complex systems.

## Basis of calculation

The calculation is based on the displacement method. The horizontal and vertical node displacements and the torsion are the unknowns of the structural system.

Deformation caused by bending and normal force is taken into account. In the second-order analysis, the actual cross-sectional properties must be used because displacement is included in the global stiffness of the system via the so-called geometric stiffness. The geometric stiffness takes the equilibrium of the deformed system into account.

## Data entry

The [wizard](#) is launched automatically when you start the program. You can enter quickly the most important key figures of the frame system in the displayed window. These values can be edited subsequently in the input section or on the [interactive graphic user interface](#) (GUI).

### Basic parameters

#### Standard and safety concept

Design standard	definition of the design standard and its national annex.
Snow as accidental load	when you check this option, snow loads are included as accidental action in addition to the typical design situations.
Load factor for snow (A)	this factor is used to determine the accidental snow load related to its characteristic value.
$\psi_2=0.5$	combination coefficient for snow and wind = 0.5 in the seismic design situation (AE).
Location in wind zone 3 and 4	when you check this option, snow action is not considered as accompanying action of wind, which is the leading action.
Consequence class	only with ÖNORM: definition of the consequence class the safety concept should be based on.
Equal $\gamma_G$	if this option is checked, all permanent loads or load cases are applied together with the same partial safety factor ( $\gamma_{G,sup}$ or $\gamma_{G,inf}$ ), otherwise permanent loads are combined independently with their lower and upper partial safety factors.

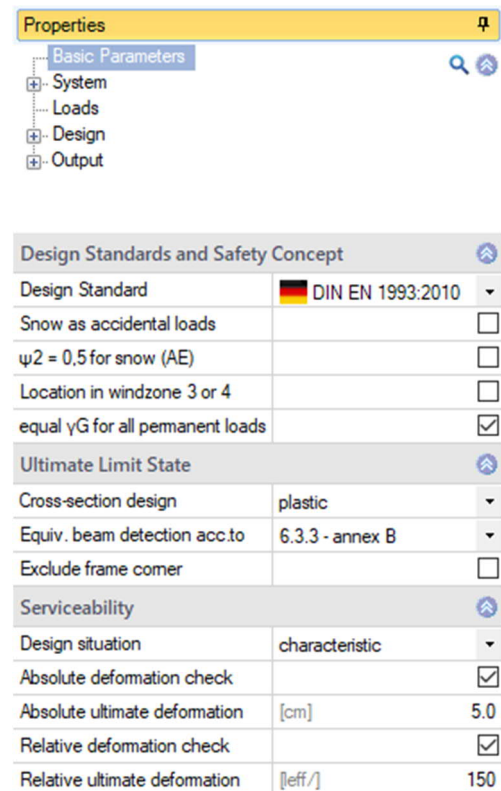

Design Standards and Safety Concept	
Design Standard	DIN EN 1993:2010
Snow as accidental loads	<input type="checkbox"/>
$\psi_2 = 0,5$ for snow (AE)	<input type="checkbox"/>
Location in windzone 3 or 4	<input type="checkbox"/>
equal $\gamma_G$ for all permanent loads	<input checked="" type="checkbox"/>
Ultimate Limit State	
Cross-section design	plastic
Equiv. beam detection acc.to	6.3.3 - annex B
Exclude frame corner	<input type="checkbox"/>
Serviceability	
Design situation	characteristic
Absolute deformation check	<input checked="" type="checkbox"/>
Absolute ultimate deformation	[cm] 5.0
Relative deformation check	<input checked="" type="checkbox"/>
Relative ultimate deformation	[eff./] 150

#### Structural safety / Ultimate Limit State

##### Cross-section design:

You can select whether the cross-section design should be based on Equation 6.1 (elastic limit values) or on Equation 6.2 (plastic).

##### Equivalent member analysis:

the equivalent member analysis is performed in accordance with 6.3.3 (Annex A or B) or 6.3.4.

##### Exclude frame corner:

when you tick this option, the verification of the cross section's load-bearing capacity is performed only up to the support face of the frame corner. No design on the idealized member support face is performed inside the shear panel area.

## Serviceability

Design situation:	verification of the serviceability in the characteristic, frequent and quasi-permanent design situations.
Absolute deformation:	performs the serviceability verification with consideration of the difference in deformation in comparison to the undeformed system.
Absolute limit deformation:	defines the permitted maximum absolute deformation of the structural system.
Relative deformation:	performs the serviceability verification with regard to the effective lengths, which are determined by the turning points (moment passage) of the bending line.
Relative limit deformation:	defines the permitted maximum relative deformation of the structural system.

## Structural system

Input / selection of material, topology, and system dimensions.

Tip: The data-entry mode for the column length (identical/different) can also be changed in the graphic screen by clicking on the lock icon.



Click to change the data-entry mode for column lengths

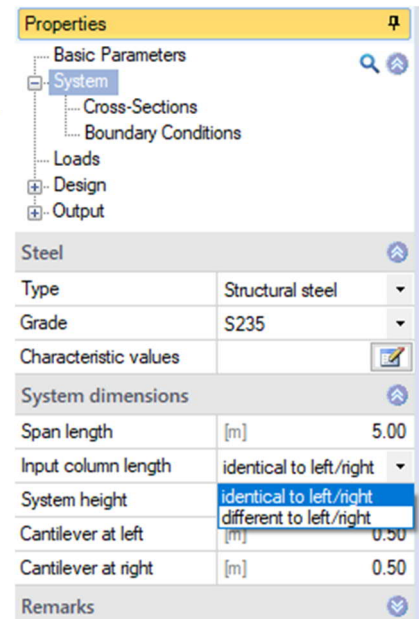

The Properties dialog box shows the following settings:

- Basic Parameters**
  - System
  - Cross-Sections
  - Boundary Conditions
- Loads**
  - Design
  - Output
- Steel**
  - Type: Structural steel
  - Grade: S235
  - Characteristic values: [Edit icon]
- System dimensions**
  - Span length: [m] 5.00
  - Input column length: identical to left/right
  - System height: identical to left/right / different to left/right
  - Cantilever at left: [m] 0.50
  - Cantilever at right: [m] 0.50
- Remarks**

## Cross-sections

The software currently handles all double-symmetrical steel shapes (double T) of the FRILO profile selection file as well as I-shapes with user-defined dimensions in their normal position.

Click on the corresponding edit button  to access the [cross-section selection](#).

To enter your own dimensions (height, width ...),

- select a profile from any steel shape series,
- activate the "Edit" function (the selected steel shape is used as basis for the user-defined profile),
- adjust the dimensions and assign a suitable name to the profile,
- save the new profile by clicking OK.

You can store your own profiles in the Frilo profile database, so that they are also available in other programs.

Moreover, you can display the structural values and define individual profiles as favourites.

[Alternative definition options in the interactive 3-d graphical user interface](#)

Click with the right mouse button on the desired component to display the context menu.

Edit cross section: you can either select one of the displayed cross-sections or add a new one.

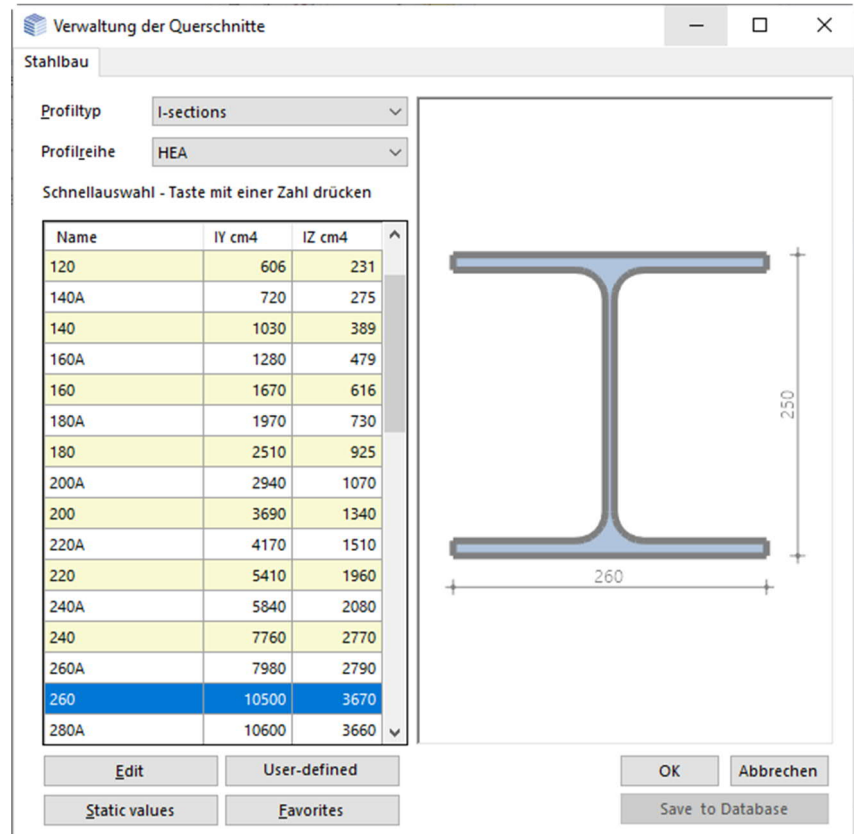

The 'Verwaltung der Querschnitte' dialog box shows the following table of I-sections:

Name	IY cm <sup>4</sup>	IZ cm <sup>4</sup>
120	606	231
140A	720	275
140	1030	389
160A	1280	479
160	1670	616
180A	1970	730
180	2510	925
200A	2940	1070
200	3690	1340
220A	4170	1510
220	5410	1960
240A	5840	2080
240	7760	2770
260A	7980	2790
260	10500	3670
280A	10600	3660

The 3D model shows an HEA 260 profile with a height of 250 mm and a width of 260 mm.

Buttons: Edit, User-defined, Static values, Favorites, OK, Abbrechen, Save to Database.

## Border conditions

The column bases (foot points) can be supported in different ways - either in a hinged or restrained manner. Under "Properties" you can achieve detailed modelling, also with specification of a spring value in x or about y.

The rotational stiffness of the frame corners can be considered in the structural system by defining torsion springs (e. g. verification of the structural system after the calculation of the connections).

If a frame corner is modelled as rigid corner, the column can be connected to the crossbeam either with a hinged connection or with a spring value.

## Warping fixity

Option marked = rigid, 0 = free, > 0 = elastic

*Note: the warping spring from a face plate is calculated as follows:  $1/3 * G\text{-modulus} * \text{width} * \text{height} * \text{thickness}^3$*

*For a column connection, the warping spring is calculated as follows:  $G\text{-modulus} * I_{t, \text{column}} * h_s$  with  $h_s = \text{distance of the centres of gravity of the flanges in the crossbeam}$*

## Supports out of plane

In the examination of components perpendicular to the frame plane, lateral supports can be taken into account for all components.

For the examination of the stability, it is important to define where the lateral supports apply to the cross-section.

Supports at the top or bottom chord or in the shear centre of the cross-section are available.

You can define the individual supports either in the Supports table on the Supports tab or in the input section via the [List entry](#).

The image shows two panels from the software interface. The top panel is titled 'Boundary Conditions' and lists various connection types with their properties. The bottom panel is titled 'Supports' and shows a table for defining support locations.

Assembly	Distance	Cy	Cy	Cpx
	[m]	[kN/m]	Member centroid	[kNm/rad]
1 Frame girder	0.00	rigid <input checked="" type="checkbox"/>	Member centroid	0.0 <input type="checkbox"/>
2 Frame girder	5.00	rigid <input checked="" type="checkbox"/>	Member centroid	0.0 <input type="checkbox"/>

This screenshot shows the 'Supports' table in the software's 3-d GUI. It includes a 'Supports' tab and a 'Load Cases' tab. The table is identical to the one shown in the previous image.

*Tip.:* Alternative definition of the border conditions in the 3-d GUI (right mouse button)

## Column base

The column bases can be stored in different ways - hinged or restrained.

You can also access the appropriate parameters under "Properties" via the context menu in the warehouse (graphics window).

This screenshot shows the 'Properties' panel in the software interface. The 'Column base' property is selected, and a context menu is open, showing options for 'hinged', 'left hinged / right clamped', 'left clamped / right hinged', 'restrained', and 'different'.



## Loads

**Self-weight** the self-weight of the frame is automatically taken into account by the program. The inclusion of self-weight can be deselected by means of this option.

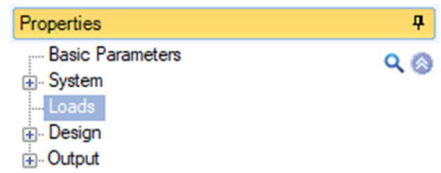

### Load cases

You can open the load case table via the tab below the graphic screen.

Alternative data entry via the load case toolbar:

see [Data entry via tables](#) (Basic Operating Instructions).

*Tip:* A description is displayed in the status line each time you click into a data-entry field.

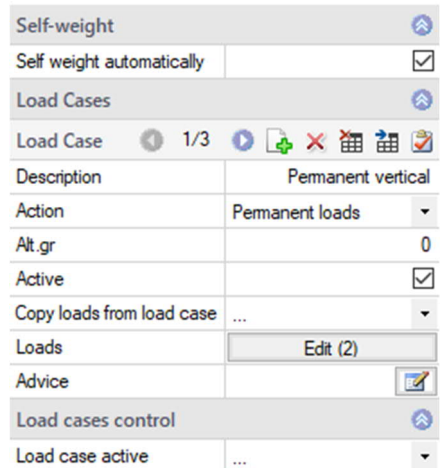

**Description** optional text to the selected action can be entered. This text is included in the output.

**Action** the appropriate actions can be selected from a list: Permanent loads ... Seismic loads.

**Active** load cases can be specifically excluded from the calculation using this option.

**Copy loads...** this function allows you to copy loads from existing load cases and edit them subsequently as required.

**Edit loads** use the "Edit" button to open a dialog for the load input with selection of the assembly (left/right support, frame girder), the load type, etc.

Use the "arrow symbol"  to call up a load value compilation - see description in the LAST+ program.

Loads									
	Assembly	Load type	Descripti...	Dirrection	Value begin	Value end	Distan...	Length	Impact point
1	Frame girder	Concentrated load	Fg,Left	crosswise to beam	140.0	---	0.00	---	Upper edge
2	Frame girder	Concentrated load	Fg,Right	crosswise to beam	140.0	---	5.00	---	Upper edge
		Concentrated load							
		Moment							
		Line load							

### Control for all load cases

Load case active: the drop-down list allows you to enable or disable load cases.

## Design

### Calculation mode

To reduce the calculation time, two calculation modes are optionally available for the total calculation in the design phase:

1. Design mode with evaluation of the calculation only in the ultimate limit state
2. Design mode with SERV, in which the serviceability is evaluated in addition.

The decisive load combinations are determined in a first-order analysis and, only for the decisive combinations, the internal forces are calculated in a second-order analysis.

### Max / Min shear values

Here you can define additional interfaces for determining the max/min internal forces.

Distance from the reference point of the assembly:

- |              |  |
|--------------|--|
| Frame girder | Origin of system axis column left with distance in horizontal direction. |
| Column       | Origin at base point with distance in vertical direction.                |

### Ultimate limit states

The load combinations decisive for the design are calculated in a second-order analysis with consideration of the initial sway imperfection.

All necessary combinations of actions are automatically considered in accordance with the safety concept set forth in EN 1990.

- Verification of the plastic cross-sectional resistance as per EN 1993-1-1, section 6.2.  
If you have activated the "Elastic design" option in the [basic parameters](#) section, the elastic verification (comparison stress verification) is performed in accordance with equation 6.1.
- Stability verifications of components as per EN 1993-1-1, para. 6.3.

### Serviceability limit states

A second-order analysis is performed for the design situation selected in the [basic parameters](#).

- Verification of absolute deformation  
The serviceability verification is based on the difference between the deformed and undeformed systems.
- Verification of relative deformation  
The serviceability verification is based on the difference in deformation related to the effective lengths. The effective lengths are determined by the inflexion points of the bending line.

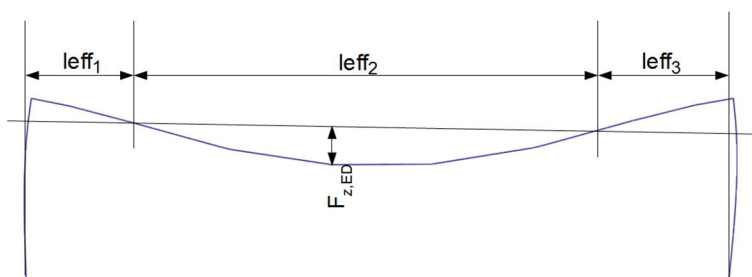

## Design of the connection details

For the design of the connections, interfaces to the Frilo programs ST3, ST6, ST10, ST14 as well as FD+ and FDB+ are available.

These interfaces provide for the direct transfer of the geometry and the internal forces of the decisive design load cases to the corresponding application program. This program must be installed and licensed on the respective computer.

First select the frame corner or support to be designed.

Click on the corresponding edit button  to launch the desired program or use the interactive graphic functions at the selected node.

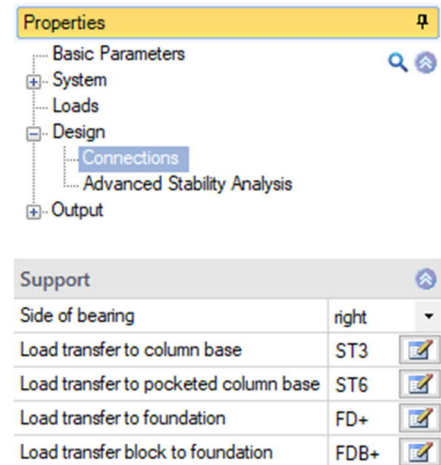

### Frame corner connection – SRE+ / ST10 / ST14 program

The verification is performed either as a bolted or welded girder-column connection.

### Load transfer of the support reactions to the programs:

ST3 – Steel Column Base

ST6 – Pocketed Steel Column Base

FD+ – Isolated Foundation

FDB+ – Block Foundation

The characteristic bearing loads per load case of the first-order analysis or, optionally, the design internal forces of the second-order analysis can be transferred.

After the transfer of the characteristic bearing loads, the decisive design load cases are determined in the activated programs.

### Enhanced stability verifications – interface BTII+

If you hold a licence for BTII+ (Lateral Torsional Buckling Analysis), you can transfer the set of members consisting of the column and the crossbeam to BTII+ for advanced stability verifications.

## Output

By checking the desired options, you can determine the scope of data to be put out.

The results are put out in the form of tables.

In the graphical output, always the decisive verification (with the highest utilization) is displayed if several sets of internal forces apply.

### Additional output sections

For the internal forces, additional output sections are possible either for the decisive combinations or the min./max. values.

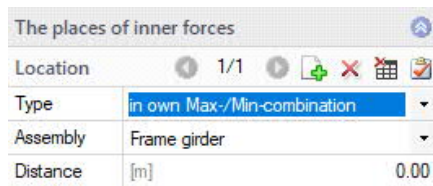

### Output as a PDF document

The Document tab displays the document in PDF and you can print it.

See also [Output and printing.pdf](#)

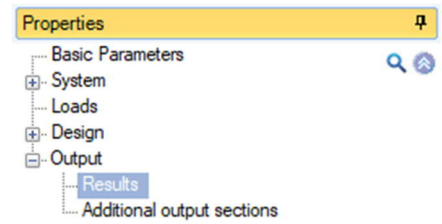

Global	<input type="checkbox"/>
Short Output	<input checked="" type="checkbox"/>
Results	<input type="checkbox"/>
Remarks	<input checked="" type="checkbox"/>
Results of Structural Elements	<input type="checkbox"/>
Check of stability	<input checked="" type="checkbox"/>
Check serviceability	<input checked="" type="checkbox"/>
Reactions / Node Forces / Deformation	<input type="checkbox"/>
Node forces II.o.	<input type="checkbox"/>
Reactions 1st.O. simple per Lc	<input checked="" type="checkbox"/>
Reactions 2nd.O.	<input type="checkbox"/>
Deformations	<input type="checkbox"/>

### Result graphs

On the "Results" tab, the various icons and options for the representation of the result graphs are displayed.

